

Accessories: Connectors BKS-S 19-11-

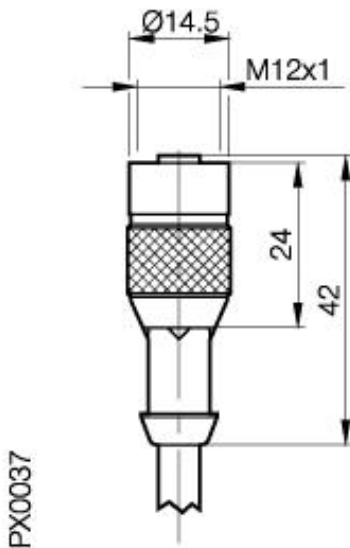

Common Data

Version	Connector, straight, 2-pin
Usable with	on Sensors NO, M12
Manufacturer	Lumberg
Ambient temperature	-25°C...+70°C
Function display	no
Supply voltage display	no

Mechanical Data

Measurements WxHxD or Dia x D	42 x Ø14,5
Material	Housing Polyester TPU
Protection class per IEC 60529	IP67
Cable version	fully potted, LiYY-0
Conductor cross section	2 x 0,34mm ²

Electrical Data

Supply voltage	10...30VDC
----------------	------------



Datasheet number::

Definitions see general catalog.
If not otherwise noted, ratings according to
IEC 60947-5-2 (DIN EN60947-5-2)

Balluff GmbH
Schurwaldstrasse 9
73765 Neuhausen a.d.F.
Phone (07158) 173-0 Fax (07158) 5010

Datenblatt by CD-ROM - 04/2007

BALLUFF
sensors worldwide